

The following features are available in this PDF document.



### **Quick Keyword Search**

Enter the keyword in the search box and hit the search button



### **Quick Jump between Chapters**

Click the title of a specific chapter on the Contents to jump to it

\*Reading software such as Adobe Reader is needed to support the functions above.



# SMOOTH-Q2

User

Guide

# Contents

■ Packing List	
Packing List.....	1
■ Get to Know SMOOTH-Q2	
Get to Know SMOOTH-Q2 .....	2
■ Battery Charging Instruction	
Battery Charging Instruction .....	3
■ Mounting and Balancing Mobile Phone	
Mounting Phone Holder.....	4
Mounting Mobile Phone.....	4
Balancing Mobile Phone .....	4
■ How to Use	
Indicator Lights and Buttons Description .....	5
Stabilizer Mode Description.....	6
Quick Switch to Standby Mode.....	8
Manual Angle Lock.....	9
Mobile Phone Charging .....	9
■ APP Operations	
Download ZY Play .....	10
How to Connect Stabilizer to Phone .....	10
ZY Play Main Function Overview.....	10
■ Calibration and Firmware Upgrade	
When to Calibrate the Stabilizer .....	11
Initialization Method.....	11

Six-Side Calibration .....	11
Motor Fine-Tuning .....	13
Firmware Upgrade .....	13

■ Product Specifications

■ Disclaimer and Warning

Reading Tip .....	15
Warning .....	15
Safe Operation Guidelines .....	16

■ Warranty Terms

Warranty Period .....	18
This warranty does not apply to the followings .....	18
Warranty Claim Procedure .....	18

■ Contact Card



Scan the QR code to watch tutorials

## Packing List

The product package comes with the following items. In case any item is found missing, please contact ZHIYUN or your local selling agent.



SMOOTH-Q2 x 1

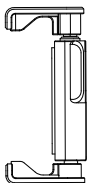

Phone Holder x 1

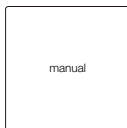

Quick Start Guide

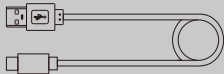

USB Type-C Cable



Wrist Strap

## Get to Know SMOOTH-Q2

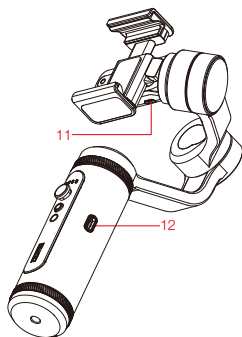
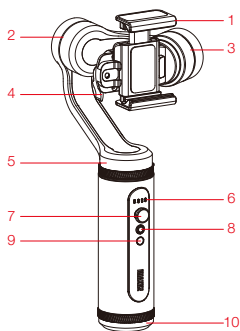

1. Phone Holder
2. Roll Axis Motor
3. Tilt Axis Motor
4. Phone Holder Latch
5. Pan Axis Motor
6. Indicator Lights

7. Joystick
8. Photo/Video Button
9. Power Button
10. Battery Cover
11. Micro USB Power Port
12. USB Type-C Charging/Firmware Update Port

## Battery Charging Instruction

SMOOTH-Q2 is equipped with 21700 Li-ion battery in a standard package. When using SMOOTH-Q2 for the first time, please fully charge the batteries to activate them and to ensure the proper function of the stabilizer.

Charging method: Please charge the stabilizer by connecting the power adapter (not included in the package, 5V2A rated power adapter recommended) with the stabilizer handle port via the applied USB Type-C cable. The four indicator lights on the stabilizer stay on when charging is completed (in the power-off state).

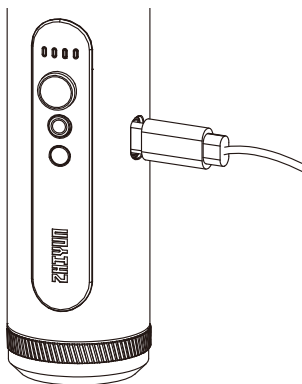

## Mounting Phone Holder

Take out the phone holder from the packing box and mount it on the stabilizer according to the following steps:

- ① Loosen the latch;
- ② Put the phoneholder close to the base plate;
- ③ Insert the phone holder into the slot and adjust it to the middle part;
- ④ Tighten the latch.

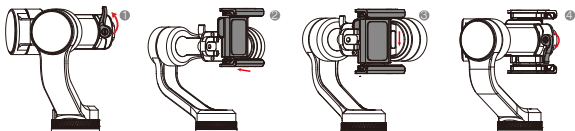

## Mounting Mobile Phone

Extend the phone holder and put the phone into the phone holder

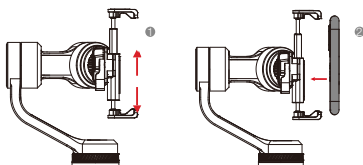

**⚠** Do not turn on the stabilizer before the mobile phone is mounted.

## Balancing Mobile Phone

Put the phone lens face up, then move the phone left or right until the phone is steady and is almost level with the ground.

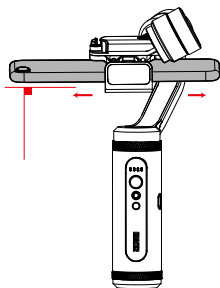

**💡** ① After the balancing, if need to take out the phone for other use, please take out it along with the phone holder and insert the phone holder into the slot to resume use.

② Press down the horizontal arm to fold up the stabilizer for storage after power-off.

**⚠** The balancing state of the mobile phone has a great impact on stabilizer runtime. The stabilizer can work even in the unbalanced state but it will consume more energy of the battery and reduce stabilizer torque.



## Indicator Lights and Buttons Description

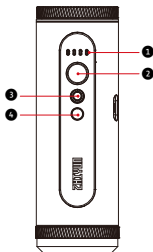

### 1 Indicator Lights

- In the working state, single white indicator light stays on to indicate the current mode of the stabilizer; The indicator for POV mode blinks when the stabilizer is in Vortex (V) mode.
- In the standby state, the four white indicator lights blink slowly.
- In low power state, the red PF light blinks slowly and the stabilizer automatically turns off one minute later.
- When charging the stabilizer in power-off state, the four white indicator lights will blink one by one to indicate the current battery level.
- The red PF indicator light will blink quickly when charging the stabilizer without any batteries.
- Single click the power button to check the battery level.  
One blinking indicator light: 0-25% battery level.  
Two blinking indicator lights: 25%-50% battery.  
Three blinking indicator lights: 50%-75% battery level.  
Four blinking indicator lights: 75%-100% battery level.

### 2 Joystick

- Four-way direction control of the camera/ lens on the stabilizer.

 After Bluetooth connected, the SMOOTH-Q2 will be able to control the native cameras of some mobile phones without ZY Play (applicable only to mobile phones that can use the volume button as a shutter button; no password needed when connecting the mobile phone to the stabilizer via Bluetooth).

- Single press to change stabilizer mode.
  - Double press to return to the previous mode.
  - Long press for 2 seconds to enter or exit standby mode
- ### 3 Photo/Video Button
- Single click to take a photo in photo mode in ZY Play App.
  - Single click to start/stop recording video in video mode in ZY Play App.
  - Double click to switch between front camera and rear camera in ZY Play App.
  - Triple click to lift the tilt axis to avoid the stabilizer arm appearing in the screen when using ultra-wide phone cameras (Invalid in Pan Following and Locking mode).
  - After Bluetooth connected, the stabilizer will be able to control the native cameras of compatible mobile phones to take photos or record videos.
- ### 4 Power Button
- Long press the stabilizer to turn on/off the stabilizer (release the button when the PF indicator light blinks).
  - Single click to check the battery level.
  - Double click to reset the motors (invalid in POV mode and Vortex mode).
  - Triple click to enter Selfie mode (invalid in Locking mode and Vortex mode)

## Stabilizer Mode Description

Single click or double click the joystick to switch between modes.

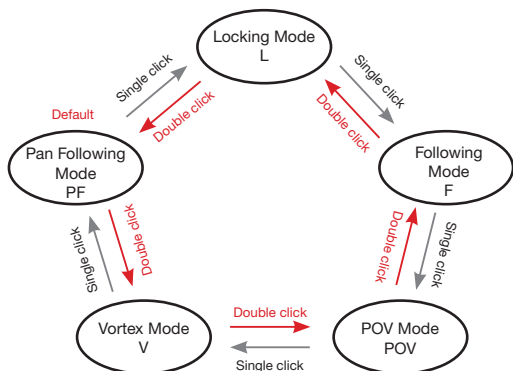

 Motors circled in red will auto move with the stabilizer, while motors circled in grey are locked.

### Pan Following Mode (PF):

Phone camera pans left/right following the movement of the stabilizer handle while the tilt and roll axis motors are locked. Push the joystick up/down to control the tilt axis.

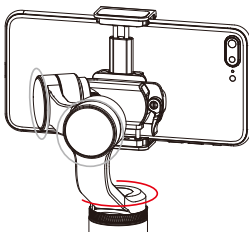

**Locking Mode (L):**

The three motors are all locked and the phone is fixed at a certain angle. Push the joystick up/down and left/right to control the tilt axis and pan axis.

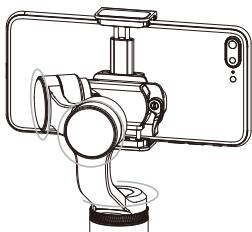
**Following Mode (F):**

The camera pans and tilts following the movement of the stabilizer. Push the joystick left/right to control the roll axis.

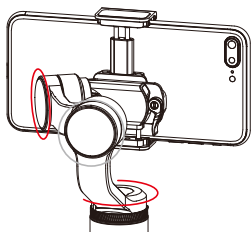
**Point of View Mode (POV):**

The three motors all follow the movement of the stabilizer handle.

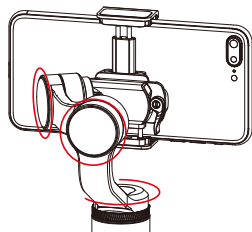

**Vortex Mode (V):**

The tilt axis rotates 90° and revolves following the movement of the stabilizer handle. Push the joystick left/right to control the pan axis.

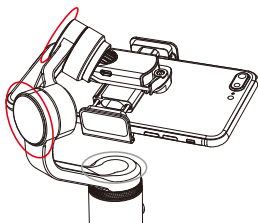
**Quick Switch to Standby Mode**

- Under the power-on state, put the horizontal arm down manually and the horizontal arm will be automatically locked into the built-in fixing buckle, then the stabilizer enters standby mode. Please pull the horizontal arm out of the built-in fixing buckle manually to restart or exit the standby state.
- Exit standby mode by resetting the horizontal arm.

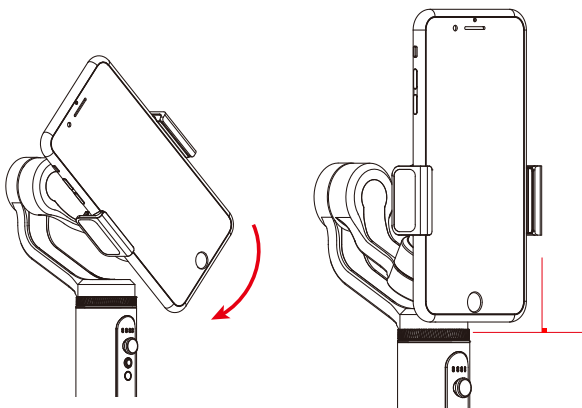

## Manual Angle Lock

Under pan following mode and locking mode, rotate the mobile phone to a certain angle by hand and release it, the mobile phone will be fixed at that angle. Manual adjustment of the tilt axis angle is available under pan following mode. Manual adjustment of tilt axis angle and pan axis angle is available under locking mode.

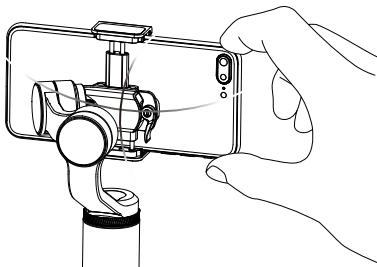

## Mobile Phone Charging

Connect your phone and the stabilizer with a charging cable (Not included in the package) (Micro USB plug at one end). Charging begins immediately after powering on the stabilizer.

**!** Micro USB Power Outlet on the tilt axis is only for charging mobile phone from the stabilizer. Charging the stabilizer from the Micro USB Power Outlet is FORBIDDEN. Otherwise, the circuit board may be burnt.

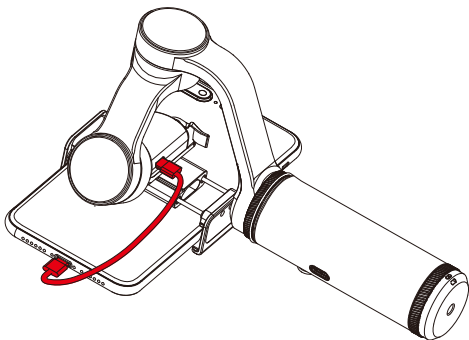

## Download ZY Play



Scan the QR code on the left (Android 5.0 and above, IOS 9.0 and above) or search "ZY Play" directly in app store to download ZY Play.

① With ZY Play that customized for SMOOTH-Q2, you will be able to make better use of the various functions of the SMOOTH-Q2.

② ZY Play is subject to regular update without prior notice.

## How to Connect Stabilizer to Phone

1. Power on the stabilizer and turn on phone Bluetooth;
2. Open ZY Play and choose the corresponding product page. Click "Connect now" and choose stabilizer Bluetooth name (check stabilizer Bluetooth name on one side of the phone holder).

## ZY Play Main Function Overview



## When to Calibrate the Stabilizer

Please calibrate the stabilizer when necessary.

Calibration Reason	How to calibrate
1. A slight deviation is found in the tilt angle of the mobile phone in level position after power-on. 2. A slight deviation is found in the roll angle of the mobile phone in level position after power-on. 3. Frequent small angle correction is found when the mobile phone is in a level position when the stabilizer stays still.	Initializing the stabilizer
1. A slight deviation is found in the level position after the initialization of the stabilizer. 2. The stabilizer has not been used for a long time. 3. The stabilizer has undergone a significant temperature difference.	Six-side calibration
A slight deviation is found in the tilt or roll angle of the mobile phone in level position after initialization and six-side calibration of the stabilizer.	Fine-tune motor force

## Initialization Method

1. Correctly install the batteries.
2. Hold the phone holder with one hand, long press the power button to power on the stabilizer; long press the joystick to enter standby mode while keeping hold of the phone holder through the whole process in case of start-up failure.
3. Put the stabilizer still on a table surface, and wait for about 30 sec, and the stabilizer will automatically complete initialization.

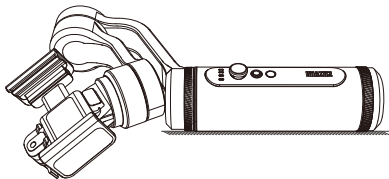

## Six-Side Calibration

1. Six-side calibration via ZY Play:

Please connect the stabilizer and ZY Play following the steps listed in "APP Operations". Enter "Calibration" and complete calibration according to the prompts given by the app.

2. Perform six-side calibration by using Zhiyun Gimbal Tools: Turn on the stabilizer and long press the Mode Button to enter into Standby Mode. Connect the USB port on the stabilizer and the computer with a USB Type-C cable. Launch calibration upgrade tool and tap "Open" to "Calibration". Proceed the calibration following the instructions. After the calibration is finished a tick "√" will appear on the screen.

- ① Please refer to the following steps for six-side calibration.
- ② In simple terms, six-side calibration is to place all six sides of the phone holder in vertical to a level surface respectively.

STEP 1

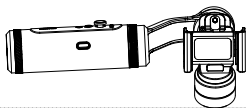
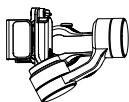

STEP 2

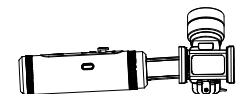

STEP 3

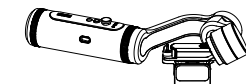
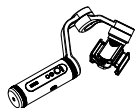

STEP 4

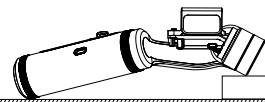

STEP 5

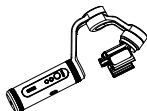

STEP 6

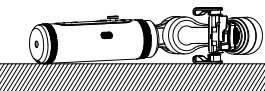



## Motor Fine-Tuning

Please connect the stabilizer and ZY Play following the steps listed in APP Operations. Enter "Fine-tune" in "Stabilizer settings" and adjust the value of the tilt and roll axis angle to your actual needs.

## Firmware Upgrade

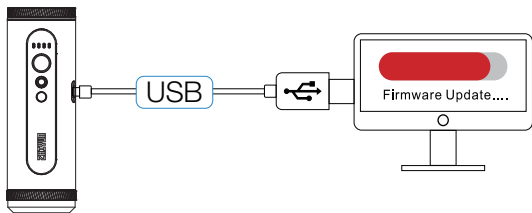

Method 1: Connect the USB port on the stabilizer and the computer with a USB Type-C cable.

1. Enter the product page of SMOOTH-Q2 on ZHIYUN's official website (<https://www.zhiyun-tech.com>) and click [Download]. Download ZHIYUN USB Driver and the latest firmware (no need to download USB Driver for Mac OS, WIN10 systems).
2. Install the USB Driver.
3. Turn on the stabilizer and long press the joystick to enter standby mode.
4. Open "Zhiyun Gimbal Tools" and update firmware according to the instructions.

Method 2 : Update firmware via ZY Play. Connect the stabilizer and ZY Play following the steps listed in "APP Operations". ZY Play will prompt users to update their firmware when new firmware is released.

- ⚠ Before updating the firmware, please make sure that the power levels of both stabilizer and phone remain above 50%. Do not turn off the stabilizer during the process or exit from ZY Play. Meanwhile, keep an eye on the prompts of ZY Play.

Product Model: SM106

	Min.	Standard	Max.	Remark
<b>Operation Voltage</b>	3.4V	3.6V	4.2V	
<b>Operation Current</b>	270mA	-	9000mA	
<b>Charging Voltage</b>	4.7V	5V	5.5V	
<b>Charging Current</b>	500mA	-	2000mA	
<b>Output Voltage (Micro USB port)</b>	-	5V	-	
<b>Output Current (Micro USB port)</b>	-	500mA	-	
<b>Tilt Mechanical Range</b>	-	305°	-	
<b>Roll Mechanical Range</b>	-	265°	-	
<b>Pan Mechanical Range</b>	-	360°	-	
<b>Working Temperature</b>	-10°C	25°C	45°C	
<b>Battery Capacity</b>	-	4500mAh	-	
<b>Working Hour</b>	-	13h	17h	LAB DATA <sup>1</sup>
<b>Charging Time</b>	-	3h	-	LAB DATA <sup>2</sup>
<b>Net Weight</b>	-	380g	-	Battery Excluded
<b>Valid Payload</b>	75g	-	260g	
<b>Phone Holder Adjustable Range</b>	65mm	-	86mm	
<b>Bluetooth</b>	Bluetooth 5.0			

"Lab Data 1": The above data is collected under the below conditions: a specified temperature of 25°C ; the stabilizer has been balanced and mounted with an iPhone 8 Plus. The test time under the active state is 13 hours. The test time under standby state is 17hours.

"Lab Data 2": This test is conducted with a 5V/2A rated power adapter at a specified temperature of 25 °C . The actual charging time varies with environmental factors. Besides, the lower the temperature, the longer the charging time.

All the data in this guide is gathered from internal experiments of ZHIYUN laboratories. Under different scenarios, data is different to some extent. Please refer to the actual use of SMOOTH-Q2.

Thank you for purchasing SMOOTH-Q2. The information contained herein affects your safety and your legal rights and responsibilities. Read this entire document carefully to ensure proper configuration before use. Failure to read and follow the instructions and warnings herein may result in serious injury to you or bystanders, or damage to SMOOTH-Q2 or nearby property. ZHIYUN reserves the right of final explanation for this document and all relevant documents relating to SMOOTH-Q2, and the right to make changes at any time without notice. Please visit [www.zhiyun-tech.com](http://www.zhiyun-tech.com) for latest product information.

By using this product, you hereby signify that you have read this document carefully and that you understand and agree to abide by the terms and conditions herein. You agree that you are solely responsible for your own conduct while using this product, and for any consequences thereof. You agree to use this product only for purposes that are proper and in accordance with all terms, precautions, practices, policies and guidelines ZHIYUN has made and may make available. Unless otherwise provided by the existing law of China, ZHIYUN is not responsible or liable for any loss or damage caused by direct or indirect use of the product and the user guide. Users should follow all security guidelines including but not limited to those mentioned in the user guide.

Unless otherwise provided by the existing law of China, ZHIYUN is not responsible or liable for any loss or damage caused by direct or indirect use of the product and the user guide. Users should follow all security guidelines including but not limited to those mentioned in the user guide.

ZHIYUN™ is the trademark of Guilin Zhishen Information Technology Co., Ltd. (hereinafter referred to as "ZHIYUN" or "ZHIYUN TECH") and its affiliates. All product names or marks referred to hereunder are trademarks or registered trademarks of their respective holders.

### Reading Tip

Legend:  Operation and Use Tips

 Important Note

Data charges may occur when you scan QR code to read or download the electronic user manual online, so you'd better process under WIFI environment.

### Warning

Read the ENTIRE User Guide to get to know the features of this product before operating. Failure to operate the product correctly can result in damage to the product or personal property and cause serious injury. This is a sophisticated product. It must be operated with caution and common sense and requires some basic mechanical ability. Failure to operate this product in a safe and responsible manner could result in injury or damage to the product or other property. This product is not intended for use by children without direct adult supervision. DO NOT use with incompatible components or in any way otherwise as mentioned or instructed in the product documents provided by ZHIYUN. The safety guidelines herein contain instructions for safety, operation and maintenance. It is essential to read and follow all of the instructions and warnings in the User Guide, prior to assembly, setup or use, in order to operate the product correctly and avoid damage or serious injury.

## Safe Operation Guidelines

### ■ CAUTION :

1. SMOOTH-Q2 is a high-precision control device. Damage may be caused to SMOOTH-Q2 if it is dropped or subject to external force, and this may result in malfunction.
2. Make sure the rotation of the gimbal axes is not blocked by external force when SMOOTH-Q2 is turned on.
3. SMOOTH-Q2 is not waterproof. Prevent contacts of any kind of liquid or cleaner with SMOOTH-Q2. It is recommended to use dry soft cloth for cleaning.
4. Protect SMOOTH-Q2 from dust and sand during use.

### ■ Warning

To avoid fire, serious injury, and property damage, observe the following safety guidelines when using, charging, or storing your batteries.

### Battery Use:

1. Prevent the batteries to come into contact with any kind of liquid. Do not leave batteries out in the rain or near a source of moisture. Do not drop the battery into water. If the inside of the battery comes into contact with water, chemical decomposition may occur, potentially resulting in the battery catching on fire, and may even lead to an explosion.
2. If the battery falls into water with the stabilizer during use, take it out immediately and put it in a safe and open area. Maintain a safe distance from the battery until it is completely dry. Never use the battery again, and dispose of the battery properly as described in the Battery Disposal section below.
3. If the battery catches fire, use water, water spray, sand, fire blanket, dry powder, or carbon dioxide fire extinguisher immediately to put out the fire. Battery-caused fire may lead to explosion. Please extinct the fire by applying the methods recommended above according to the actual situation.
4. Never use non-ZHIYUN batteries. If replacement or backup is needed, please purchase new batteries from ZHIYUN's official website or authorized channels. ZHIYUN takes no responsibility for any damage caused by non-ZHIYUN batteries.
5. Never use or charge swollen, leaky, or damaged batteries. Never use or charge if the battery smells, or overheats (exceeding maximum temperature of 160 ° F/71 ° C). If your batteries are abnormal, contact ZHIYUN or a ZHIYUN authorized dealer for further assistance.
6. The battery should be used within the temperature range from -10 ° C to 45 ° C. Use of battery in environments above 45° C may lead to a fire or explosion. Use of battery below -10° C may lead to serious battery damage.
7. Do not use the battery in strong electrostatic or electromagnetic environments. Otherwise, the battery protection board may malfunction.
8. Do not disassemble or use any sharp object to puncture the battery in any way. Otherwise, the battery may leak, catch fire or explode.
9. Do not mechanically strike, crush, or throw the battery. Do not place heavy objects on the battery or charger.
10. Electrolytes inside the battery are highly corrosive. In case of accidental contact of any electrolytes with your skin or eyes, rinse immediately with water for at least 15 minutes and seek medical advice as soon as possible.

11. Do not use the battery if it has been involved in a crash or heavy impact.
12. Do not heat the battery and never put the battery in a microwave oven or in a pressurized container.
13. Do not place the battery on a conductive surface (such as a metal desk surface, eye-glasses, watch, jewelry, etc.)
14. Prevent use of wires or other metal objects that could cause positive and negative short-circuit to the battery.
15. If the battery terminal is dirty, wipe it with a clean, dry cloth. Otherwise it will cause a bad battery connection, which may result in energy loss or charging failure.

### **Battery Charging:**

1. The battery will automatically stop charging once it is full. Please disconnect the battery and the charger when fully charged.
2. Do not attach the batteries to a wall outlet or car charger socket directly. Always use a ZHIYUN approved adapter for charging. ZHIYUN takes no responsibility if the battery is charged using a non-ZHIYUN charger.
3. Do not put the battery and charger near flammable materials or on flammable surfaces (such as carpet or wood). Never leave the battery unattended during charging to prevent any accident.
4. Do not charge the battery immediately after use, because the battery temperature may be too high. Do not charge the battery until it cools down to normal room temperature. Charging the battery with its temperature over 45° C or lower than 0° C may lead to leakage, overheating, or damage.
5. Examine the charger before use, make sure there is no damage to the enclosure, cord, plug, or other parts. Never use a damaged charger. Do not clean the charger with any liquid containing alcohol or other flammable solvents. Disconnect the charger when not in use.

### **Battery Storage:**

1. Keep batteries out of the reach of children and pets.
2. Do not leave the battery near heat sources such as a furnace or heater, or inside of a vehicle on hot days. Never expose the battery in any environment with temperature of over 60° C. The ideal storage temperature is 22° C-28° C.
3. Store batteries in a dry environment.
4. Do not leave the battery unused for too long after it has been completely discharged to prevent over-discharge of battery which may result in battery damage and permanent failure.

### **Battery Maintenance:**

1. Do not over-charge or over-discharge the battery, which will damage the battery.
2. The battery performance will be affected for not being used for a long time.
3. Never use the battery when the temperature is too high or too low.
4. Do not store the battery in any environment with a temperature of over 60° C.

### **Battery Disposal:**

1. Please fully discharge the battery before putting it in the designated recycling bin. Batteries contain hazardous constituents and it is forbidden to put the battery in general waste bin. For related details please abide by the local laws and regulations on battery recycling and disposal.
2. If the battery cannot be fully discharged, never put it in battery recycling bin. Please contact battery recycling companies for a proper solution.

### Warranty Period

1. Customers are entitled to replacement or free repair service in case of quality defect(s) found in the product within 15 days upon receipt of the product.
2. Customers are entitled to free repair service from ZHIYUN for any product proven defective in material or workmanship that results in product failure during normal consumer usage and conditions within the valid warranty period, which is 12 months counting from the date of selling.

### This warranty does not apply to the followings

1. Products subjected to unauthorized repair, misuse, collision, neglect, mishandling, soaking, accident, and unauthorized alteration.
2. Products subjected to improper use or whose labels or security tags have been torn off or altered.
3. Products whose warranty has expired.
4. Products damaged due to force majeure, such as fire, flood, lightening, etc.

### Warranty Claim Procedure

1. If failure or any problem occurs to your product after purchase, please contact a local agent for assistant, or you can always contact ZHIYUN's customer service through email at [service@zhiyun-tech.com](mailto:service@zhiyun-tech.com) or website at [www.zhiyun-tech.com](http://www.zhiyun-tech.com).
2. Your local agent or ZHIYUN's customer service will guide you through the whole service procedure regarding any product issue or problem you have encountered. ZHIYUN reserves the right to reexamine damaged or returned products.

#### Customer information

Customer Name : Contact No :

Address :

#### Sales Information

Sales Date : Prod. Serial No :

Dealer :

Contact No ::

#### #1 Maintenance Record

Service Date : Signature of Repairman :

Cause of Problem :

Service Result :  Solved  Unsolved  Refunded(Replaced)



Website



Weibo



Vimeo



Google+



Facebook  
(Zhiyun Support)



Facebook  
(Zhiyun Tech)



Youku



Youtube



Wechat



Instagram

Tel: +86 400 900 6868

USA Hotline: +1 808-319-6137,9:00-18:00 GMT-7,Mon-Fri

Europe Hotline: +49 (0) 61018132180,10:00-17:00 GMT+1,Mon-Fri

Web: [www.zhiyun-tech.com](http://www.zhiyun-tech.com)

E-mail: [service@zhiyun-tech.com](mailto:service@zhiyun-tech.com)

Address: 09 Huangtong Road, Tieshan Industrial Zone, Qixing District, Guilin, 541004, Guangxi, China

## Certificate of Quality

This product is confirmed to meet quality standards and permitted for sale after strict inspection.

QC Inspector: \_\_\_\_\_



Please download the latest version from [www.zhiyun-tech.com](http://www.zhiyun-tech.com)

This document is subject to change without notice.

ZHIYUN™ is a trademark of ZHISHEN.

All other trademarks cited herein are the property of their respective owners.

Copyright © 2020 ZHISHEN. All rights reserved.



ZHIYUN-TECH.COM